

4/24/97

**MODEL ADS-640**

FINAL CONTINUED ON NEXT PAGES

**802247  
TOP LEVEL ASSEMBLY**

- 212006 (5)  
BNC COVER
- 220840  
LOGO PLATE
- 222218  
SUPPLEMENT TO MANUAL
- 222256  
DISK, SUPPORT
- 610023  
LINE CORD, STRAIGHT
- ADS-640 MAN  
MANUAL

**802299  
COVER ASSY**

- 140011  
BAG
- 222170-014  
COVER
- 255008 (5)  
FOAM STRIP
- 255010 (2)  
RUBBER FOOT
- 255060 (4)  
LATCH
- 255061 (AR)  
VELCRO
- 281624 (2)  
SOC HD 6-32 X 3/4
- 283210 (4)  
PAN HEAD 2-56 X 1/4
- 288010 (4)  
WASHER SPLIT #2
- 288012 (2)  
WASHER SPLIT #6
- 288030 (4)  
WASHER FLAT #2
- 288033 (4)  
WASHER FLAT #6
- 289060 (2)  
HEX NUT #6

**802248  
FINAL ASSEMBLY**

- 171057  
JAZ DRIVE INT PC
- 171058  
SCSI ADAPTER
- 171061  
ADAPTER BD
- 222160  
WINDOW
- 281408 (6)  
SOC HD 4-40 X 1/4
- 281612 (2)  
SOC HD 6-32 X 3/8
- 283392  
PAN HD SLOTTED
- 288011 (6)  
WASHER SPLIT #4
- 288012 (17)  
WASHER SPLIT #6
- 288041 (6)  
WASHER FLAT #4
- 288042 (17)  
WASHER FLAT #6
- 288524 (4)  
CABLE TIE HOLDER
- 288607 (AR)  
CABLE TIE
- 289060 (15)  
HEX NUT #6
- 513010  
KEYBOARD

**802249  
CASE ASSEMBLY**

- 141030  
HANDLE
- 222157 (2)  
BRACKET
- 222158-014  
CASE
- 222161  
HINGE
- 222165 (2)  
FLANGE, SIDE GASKET
- 222166  
FLANGE, TOP GASKET
- 255010 (4)  
RUBBER FOOT
- 255045 (AR)  
GASKET, WIRE MESH
- 255057 (2)  
CORNER RECEPTACLE
- 255059 (4)  
LATCH, KEEPER
- 262005  
FINGER GUARD/ FILTER
- 281212 (8)  
SOC HD 2-56 X 3/8
- 281412 (4)  
SOC HD 4-40 X 3/8
- 281616 (4)  
SOC HD 6-32 X 1/2
- 283210 (8)  
PAN HD 2-56 X 1/4
- 283320 (9)  
FLAT HD 6-32 X 1/4
- 283390 (4)  
FLAT HD M4 X 10MM
- 283652 (4)  
PAN HD 6-32 X 5/8
- 284612 (5)  
BIND HD 6-32 X 3/8
- 288010 (16)  
WASHER SPLIT #2
- 288011 (4)  
WASHER SPLIT #4
- 288012 (17)  
WASHER SPLIT #6
- 288040 (8)  
WASHER FLAT #2
- 288041 (4)  
WASHER FLAT #4
- 288042 (17)  
WASHER FLAT #6
- 289060 (8)  
HEX NUT #6
- 400522  
LAMBDA SUPPLY
- 549021 (AR)  
LOCTITE

**802252  
POWER HARNESS**

- 211020 (2)  
MOLEX CONN 4 SOC
- 211042  
MOLEX CONN 3 SOC
- 211185  
CONN 10 PIN RECEPT
- 214006 (2)  
FEMALE CONTACT
- 214031 (8)  
CONTACT
- 313004 (AR)  
HEAT SHRINK

**802253  
FAN ASSY**

- 211043  
MOLEX CONN 3 PIN
- 214005 (2)  
MALE CONTACT
- 261017  
FAN
- 313004 (AR)  
HEAT SHRINK

**802282  
HARD DRIVE**

- 141031  
ANTI VIBE CHASSIS
- 171060  
HARD DRIVE

**802283  
RIBBON CABLE**

- 211222 (2)  
CONN RIBBON 44 PIN
- 610007 (AR)  
CABLE 44 COND

**MISCELLANEOUS INFORMATION**

802348 | FIELD UPGRADE PROCEDURE, VGA

SCHEMATIC #	PART NO.	DESCRIPTION
900478	802251	ANALOG BOARD



EPC LABS DANVERS

TITLE:  
ADS-640 TREE

DRAWN BY:  
JUDE GARLINGTON

DATE:  
4/17/97

REV: B

ADS-640

FINAL ASSEMBLY 802248 (CONT)

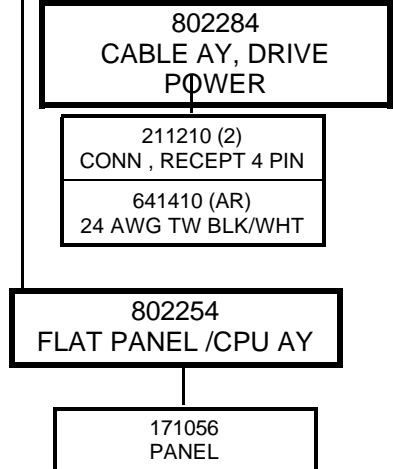
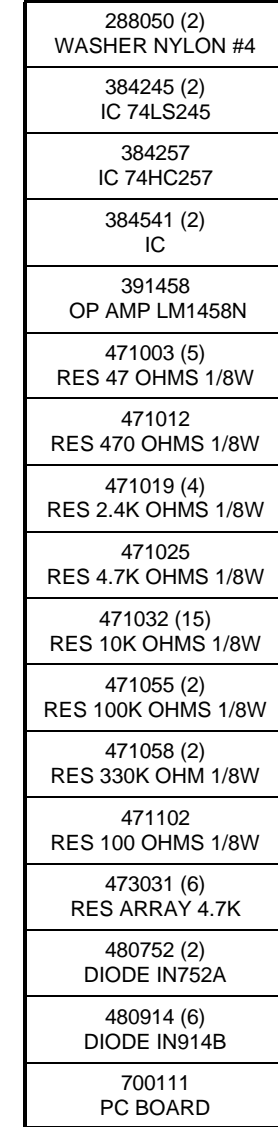
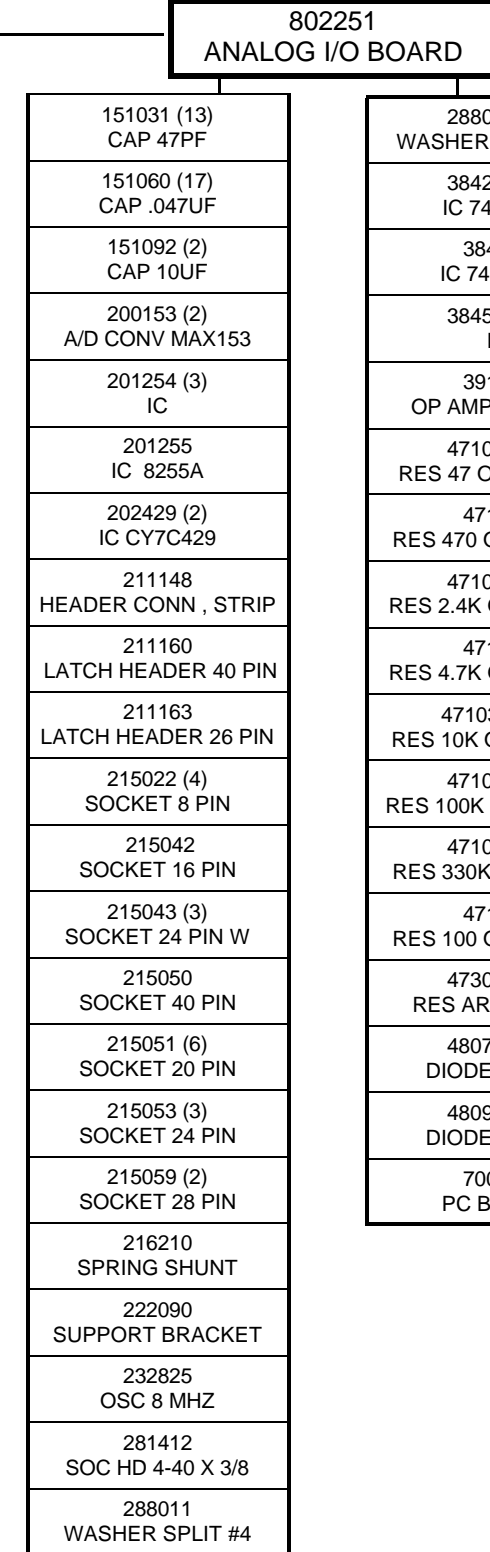
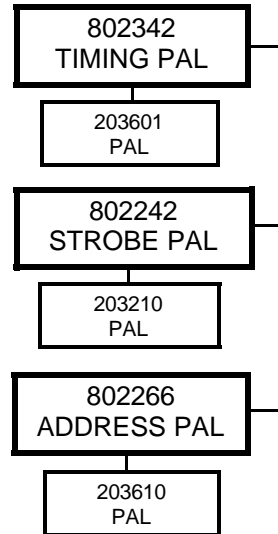
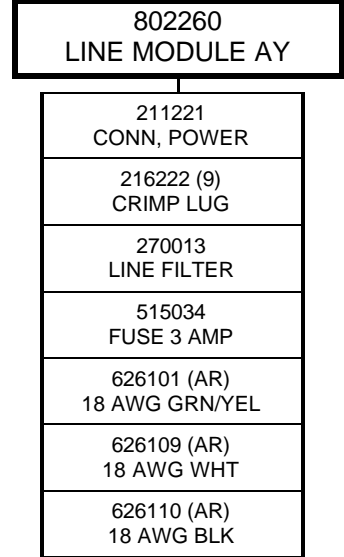
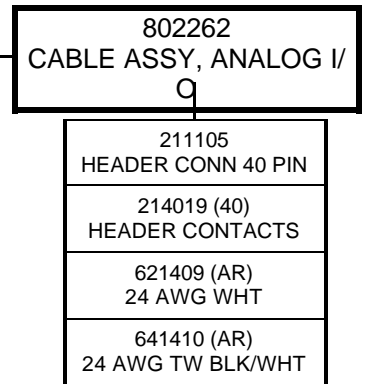
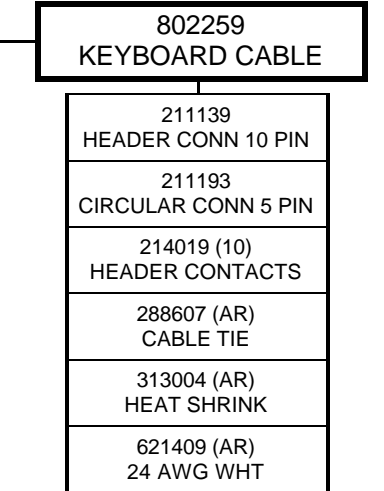
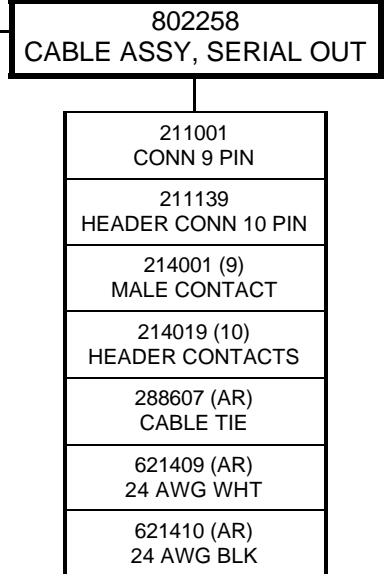
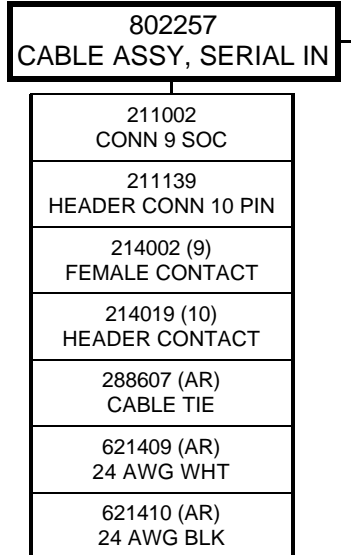
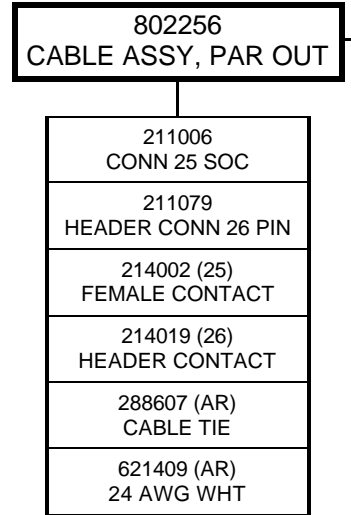
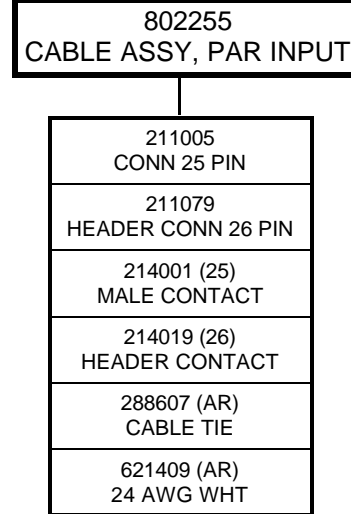
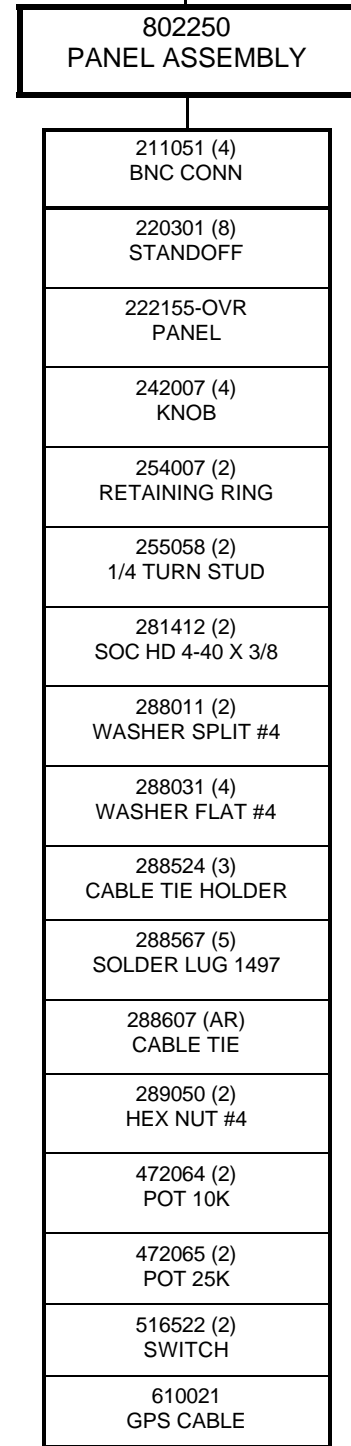

REV	DESCRIPTION	ECO
<b>A</b>	ADDED FIELD UPGRADE PROCEDURE, VGA	<b>1434</b>
B	ADDED 222256 SUPPORT DISK	1521